

RC-4a

Mammography Screening

Dr K Faulkner

Quality Assurance Reference Centre (Screening),
Newcastle upon Tyne, United Kingdom

MAMMOGRAPHY SCREENING

Dr K Faulkner

Quality Assurance Reference Centre
Unit 9
Kingfisher Way
Silverlink Business Park
Wallsend
Tyne and Wear
NE28 9ND

keith.faulkner@nhs.net

Abstract

The objective of any screening programmes is to test a population group to identify a sub-group who have disease at an early stage. For a screening programme to be effective there should be a suitable test or examination. In addition there must also be a treatment which confers benefit when the sub-group is treated at an early stage. In breast screening, the test used to identify breast cancer at an early stage is x-ray examination mammography. This examination is only of benefit if early breast cancers (i.e. small tumours) are detected, this requires obtaining and maintaining high quality mammography. This may only be delivered if there is rigorous and comprehensive quality assurance of x-ray mammography. The use of ionising radiation as an intrinsic part of the screening process means that screening must be justified in radiation protection terms as well. The benefit to the screened population must exceed the risk. Thus dose assessment must be an integral part of screening. Mammography screening can only be successful in reducing fatal breast cancer deaths, thus there must be quality assurance of the process. A comprehensive quality assurance programme for breast screening is described in detail.

1 Introduction

The objective of any screening programme is to apply a test to a population group, to identify a sub-group who have disease at an early stage. For a screening programme to be effective there must be a suitable test or examination. In addition, this sub-group must also benefit from a better prognosis when detected early or at a stage before symptoms develop. In other words, if the sub-group is treated early they must survive longer than if they had been treated once symptoms have developed.

In breast screening high quality x-ray mammography is used to detect breast cancer. This examination only confers benefit on the screened population if it detects breast cancer at an early stage, where the prognosis is improved. This can only be achieved by having high quality mammography which is capable of detecting small lesions in the breast. High quality mammography must be achieved and maintained by a rigorous and comprehensive quality assurance and control programme.

The general principles of screening are (1):-

- 1) The condition screened for should pose an important health problem.
- 2) The natural history of the condition should be well understood.
- 3) There should be a recognisable latent or early stage.
- 4) Treatment of disease at an early stage should be of more benefit than treatment started at a later stage.
- 5) There should be a suitable test or examination.
- 6) The examination should be acceptable to the population.
- 7) For diseases with an insidious onset, screening should be repeated at intervals determined by the natural history of the disease.
- 8) There should be adequate facilities available for the diagnosis and treatment of any abnormalities detected.
- 9) The chance of physical or psychological harm should be less than the chance of benefit.
- 10) The cost of funding (including diagnosis and subsequent treatment) should be economically balanced against the benefit it provides.

Screening, using x-ray mammography, for the detection of breast cancer at an early stage is a well established public health measure. In the National Health Service Breast Screening Programme, women between the ages of 50 and 70 are offered three yearly x-ray mammography. Screening above the age of 70 is available on request. Low energy x-rays are used to image the breast, in order to detect small, low contrast lesions in the breast. High image quality and low doses are demanded of x-ray mammography, as smaller cancers have a much better prognosis.

The basic principles of radiation protection are justification and optimisation. Justification applies to both the population and at an individual level. For the screened population it requires that the benefit, in terms of additional lives saved, are greater than the risk from the use of ionising radiation. In a screening programme, optimisation implies that the benefit is maximised by improving image quality and hence the cancer detection rate. This demands that screening mammography is subject to a comprehensive quality control programme.

2 Mammography

Mammography is an X-ray examination of the breast that requires specialised imaging equipment and techniques. The low inherent radiation contrast between fat and glandular tissue necessitates the use of specially filtered X-ray beams generated in an X-ray tube with a special target at a tube potential in the range of 28-32 kV. The X-ray tube must use a small focal spot (e.g. 0.1 to 0.4 mm). The most commonly used tubes have a molybdenum target

with a 30 µm molybdenum filter. For thick, dense breasts tungsten and rhodium target X-ray tubes with appropriate beam filters may provide advantages (2).

In order to minimise radiation dose and to reduce the effect of scattered radiation on the film, the breast must be compressed. The mammography unit may also have a moving or stationary grid. In general, radiographs are acquired using a single emulsion film placed in an X-ray cassette with a single back screen to optimise image detail. Specialised, preferably dedicated, film processing is also desirable.

3 Quality Assurance and Quality Control

As stated by the, WHO quality assurance in diagnostic radiology is: “All those planned and systematic actions necessary to provide adequate confidence that a structure, system or component will perform satisfactorily in service (3). Satisfactory performance in service implies the optimum quality of the entire diagnostic process, i.e. the consistent production of adequate diagnostic information with the minimum exposure of both patients and personnel.” Thus the main objectives of a quality assurance (QA) programme are to improve diagnostic accuracy without unnecessary radiation and to minimise costs.

3.1 Quality Assurance Programme

The responsibilities for performing the various QA and quality control (QC) procedures are delegated to X-ray operators, radiographers, and medical or health physicists depending on the size of the facility.

Three levels of testing are usually performed.

1. Acceptance tests.
2. Status tests.
3. Constancy tests.

Acceptance tests are performed when equipment is purchased to ensure that it meets its contractual specification. Status tests are undertaken to determine the absolute performance of equipment and may be included in the acceptance test. The purpose of the constancy test is to monitor the consistency of performance of the equipment. What constitutes an acceptance test, status test or constancy test is dependent on the type of equipment. It is difficult to be prescriptive about QA and QC test methods and frequencies that are applicable in all situations in diagnostic radiology. An automatic film processor may require monitoring on a daily basis, whereas it may only be necessary to check the tube filtration when an X-ray tube has been replaced. Similarly, the tests performed on a new image intensifier fluoroscopy unit will differ from those undertaken if the consideration is whether an old unit is to be taken out of service or not. Advice on test frequencies for mammographic QC testing is given in Appendix 1 which is adapted from a previously published protocol (4).

The Basic Safety Standards (5) state that registrants and licensees shall establish a comprehensive quality assurance programme for medical exposures with the participation of qualified experts in appropriate fields (i.e. radiodiagnostic physics), “taking into account the principles established by the WHO and the PAHO”.

In a manual of this kind it is impractical to describe in detail QA and QC tests that should be performed on all types of diagnostic radiology equipment. There have been numerous publications on QA and QC test methods and it is suggested that the reader refer to these manuals for further guidance.

4 Appendix 1

Test Frequencies

This Appendix lists all the tests in the order given in the protocol, together with the suggested frequencies at which they might be undertaken. The list may not be exhaustive, but will certainly be exhausting and readers may need to be selective. Frequencies should be regarded as tentative and may need to be altered in the light of experience or according to local circumstances. All the tests are regarded as being part of the commissioning process; a frequency is not shown if the test does not need to be repeated after commissioning. Some of the safety tests may need to be repeated more frequently for equipment fitted in mobile trailers. Repairs and maintenance may necessitate additional tests.

(Key: D=Daily to Weekly, M=3 to 6 Monthly, A=Annually)

Electrical Safety

Mechanical Safety

- | | |
|---|---|
| 1. Table movement prevented under compression | A |
| 2. Compression auto-release | M |
| 3. Auto-release override | M |
| 4. Emergency release | M |
| 5. Maximum compression force | M |
| 6. No sharp edges | A |
| 7. Field light | A |
| 8. Screen edges marked | - |
| 9. Adequate retraining devices on mobiles | A |

Mechanical Functioning

- | | |
|--------------------------------|---|
| 1. Equipment complete | A |
| 2. Markings | A |
| 3. Free movements | M |
| 4. Brakes | A |
| 5. Scale markings | A |
| 6. Vertical movement | A |
| 7. Foot switches | A |
| 8. Attachments | A |
| 9. Field sizes marked | A |
| 10. AEC detector | A |
| 11. Cassette movement | A |
| 12. Cassette interlock | A |
| 13. Light intensity | A |
| 14. Compression plate movement | M |
| 15. Breast thickness scale | A |

Radiation Safety Inspection

- | | |
|-----------------------------------|---|
| 1. Mains isolator position | - |
| 2. Clear control markings | A |
| 3. Mains-on light | A |
| 4. X-rays-on light | A |
| 5. Total filtration | A |
| 6. Added filter interlock | A |
| 7. Diaphragm interlock | A |
| 8. Exposure termination | A |
| 9. Exposure control position/lead | A |
| 10. Exposure control design | - |
| 11. Exposure control function | A |

| | |
|---|-------------|
| 12. Entrance warning light | A |
| 13. Lead equivalence markings | - |
| 14. Lead equivalence | - |
| 15. Protective screen gap | A |
| 16. Visibility | A |
| Radiation Safety Measurements | |
| Tube leakage | (a) |
| Lead equivalence of screen | - |
| Table transmission | - |
| Separation of film/table edge | A |
| Alignment of x-ray field to film/cassette | M |
| Alignment of light/x-ray field | M |
| Additional checks for mobiles | As required |
| X-ray Measurements | |
| X-ray field non-uniformity | A |
| Dimensions of focal spot | |
| Slit camera | (b) |
| Star resolution grid | M |
| Pinhole | As required |
| Tube kilovoltage | |
| Brief check | M |
| Full check | A |
| HVL filtration | A |
| Exposure time | A |
| Output | |
| Consistency | M |
| With change in kV | M |
| With change in tube current/focus | A |
| Magnification | - |
| Grid factor/grid system factor | - |
| Grid film | A |
| Automatic Exposure Control | |
| Consistency | M |
| Sensitive area of AEC detector | - |
| Phantom thickness | M |
| Tube voltage | M |
| Tube current | A |
| Other parameters | A |
| Calibration of density control | A |
| Guard timer | A |
| Regular test | D |
| Automatic processing unit (APM) | |
| Sensitometry | D |
| APU temperature | D |
| Transport speed | As required |
| Replenishment rate | As required |
| Specific gravity/pH | As required |
| Residual hypo | As required |
| Silver recovery | As required |
| Screen-film system | |
| Cassette and screen identification | M |
| Screen-film contact | M |
| Light-tightness of cassette | M |
| Relative sensitivity of screen-cassette | M |
| Characteristic curve of screen-film | As required |

| | | |
|-------------------------------|-------------|---|
| Dark room and film storage | | |
| Light-tight darkroom | | A |
| Safelights/warning lights | | A |
| Temperature | | A |
| Humidity | | A |
| Stock control | | D |
| Illuminators and viewing room | | |
| Visual check | | M |
| Illuminator light level | A | |
| Ambient light level | | A |
| Breast dose | | |
| Dose to standard breast | M | |
| Alternative method | | A |
| Routine monitoring | | D |
| Image quality | | |
| Optimisation | As required | |
| Routine check | D | |
| Stereotactic systems | A | |
| Specimen x-ray cabinets | | |
| All tests | | A |

Notes:

(a) = 3 yearly

(b) = may need to be checked more frequently

5 References

1. Wilson J M G, Junger G. 1968. Principles and practice of screening or disease (World health Organisation, Geneva). WHO Public Health Paper 34.
2. Young KC, Ramsdale ML, Rust A. Dose and image quality in mammography with an automatic beam quality system. British Journal of Radiology 1996 69:555-562.
3. World Health Organisation. 1982 Quality Assurance in Diagnostic Radiology. (WHO, Geneva).
4. Institute of Physics and Engineering in Medicine. 1994 The commissioning and routine testing of mammographic x-ray systems. Report 59 (Second Edition). (IPEM, York).
5. International Atomic Energy Agency. 1995 Basic Safety Standards. (IAEA, Vienna).



International Radiation Protection Association 11th International Congress Madrid, Spain - May 23-28, 2004

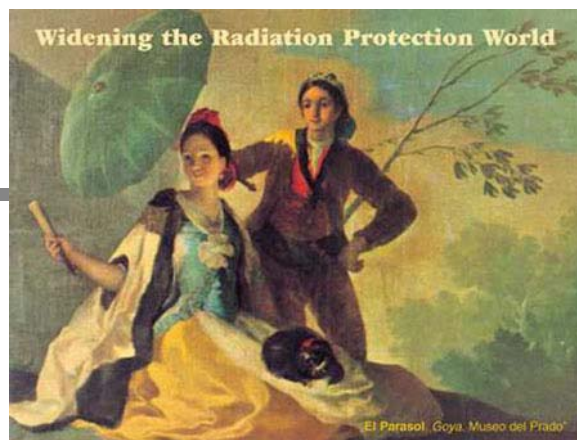

RC-4a Screening Mammography Including Quality Assurance

Keith Faulkner

keith.faulkner@nhs.net

NHSBSP

- Women aged 50 – 70 years screened
- X-ray mammography
- Two views all rounds
- Mainly double read





High Quality Images Required

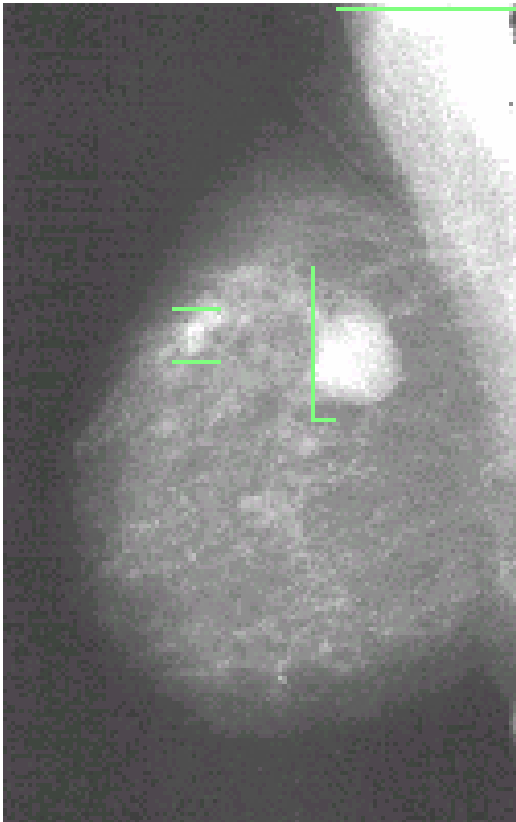

This means rigorous QA

Breast Cancer Detection Rates (per 1,000 England)

| Age Band | 94-95 | 95-96 | 96-97 | 97-98 | 98-99 | Mean |
|----------|-------|-------|-------|-------|-------|------|
| 50-54 | 4.3 | 4.6 | 5.0 | 5.4 | 5.5 | 5.0 |
| 55-59 | 4.7 | 4.7 | 5.0 | 5.3 | 5.5 | 5.0 |
| 60-64 | 6.3 | 5.9 | 6.1 | 6.1 | 6.8 | 6.2 |



QUALITY ASSURANCE PROGRAMS (I)

- A quality assurance program may be defined (WHO definition) as an **organized effort** by the staff operating a facility to ensure that the diagnostic images produced by the facility are of sufficiently **high quality** so that they consistently provide adequate diagnostic information at the **lowest possible cost** and with the **least possible exposure** of the patient to radiation.



QUALITY ASSURANCE PROGRAMS (II)

- Radiology imaging equipment should produce images that meet the needs of the radiologist or other interpreters **without involving unnecessary irradiation of the patient.**
- Quality assurance actions contribute to the production of **diagnostic images of a consistent quality** by reducing the variations in performance of the imaging equipment.



QA Objectives

- The aim of quality assurance in the breast screening programme is the maintenance of minimum standards and the continuous improvement in performance



QA Objectives

- To review the performance and outcomes of breast screening and individual units
- To provide advice and continuing professional education for individuals
- To support health authorities and trust in the specification, commissioning and delivery of screening to meet national standards



QA Team

- Professional members are appointed with a clear job description and a paid commitment
- Accountable to the regional QA director
- QA Director is accountable to the RDPH



QA Visit Visiting Team

- Radiology
- Radiography
- Pathology
- Surgery
- Breast care nursing
- Administration and clerical
- Medical physics



National QA Guidelines

- NHSBSP documents
- Revised Pritchard standards
- Professional QA guidance
- QA visit protocol



QA Visit

- Verifies the achievement of national standards and identify variance from these standards
- Support professionals working in the programme to maintain and improve standards of professional performance



QA Visit

- Take place every three years
- Multidisciplinary
- Take place in the breast screening unit



QA Visit Written Report

- Comment on screening outcomes and interval cancer rates
- Identify strengths and weaknesses in the unit
- Recommend actions and a timescales for their implementation



Incident Investigation

- QA Director informed of potential incident
- Set up a team to determine nature and extent of incident
- Follow NHSBSP protocol
- Establish if it is an incident
- Hand it over to the Trust
- Keep RDPH and National Office informed



Physics QA Programme

- Acceptance testing
- Constancy testing
- Status testing



Electrical Safety

- Responsibility of the supplier
- IEC 601-1
- Department of Health TRS 89 Technical requirements for the supply and installation of apparatus for diagnostic imaging and radiotherapy



Mechanical Safety

- Prevention of powered movement under compression
- Automatic release of compression plate after an exposure
- 200N maximum powered compression force
- No sharp edges



Marking and Labelling

- Focal spot size and position
- Inherent, added and total filtration
- AEC position
- Magnification factor
- Function of all controls



Mechanical Function Checks

- All manually controlled movements
- Mechanical/electromechanical brakes
- Scales/indicators
- Beam diaphragms
- Foot switches
- Attachments
- AEC position selector



Radiation Safety

- Mains isolator switch
- Mains on light
- Exposure light
- Total filtration 0.5mmAl/0.03mmMo
- Diaphragm interlock
- Exposure termination if button released

Alignment

- Light field to X-ray field
- X-ray field to film
- Field edge and edge of breast support platform
- Imaged area for digital systems

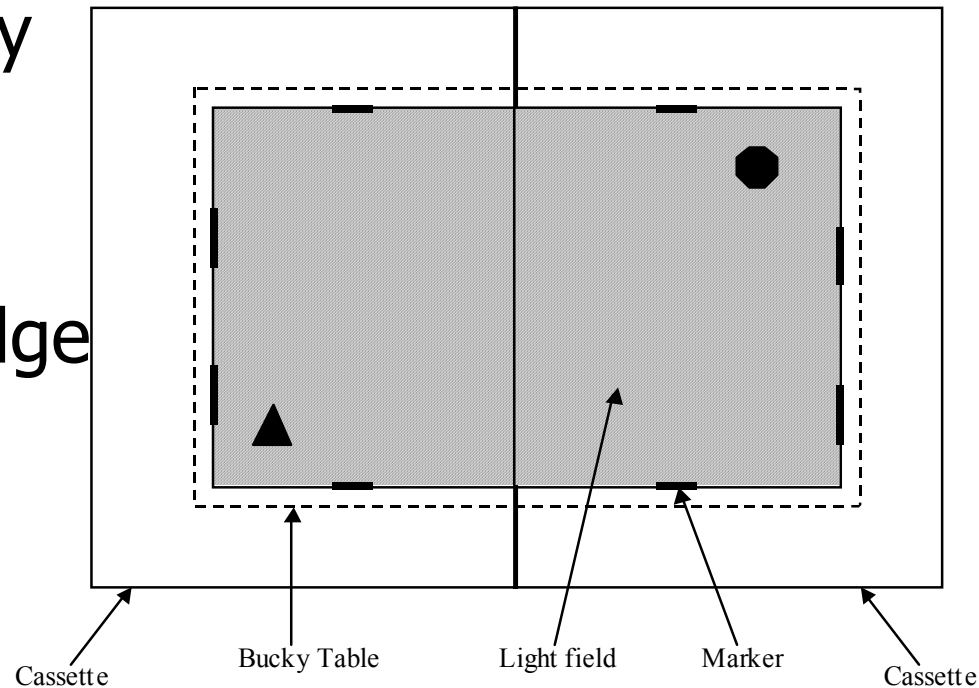

X-ray field to film

Alignment $>0\text{mm}$ and $<5\text{mm}$

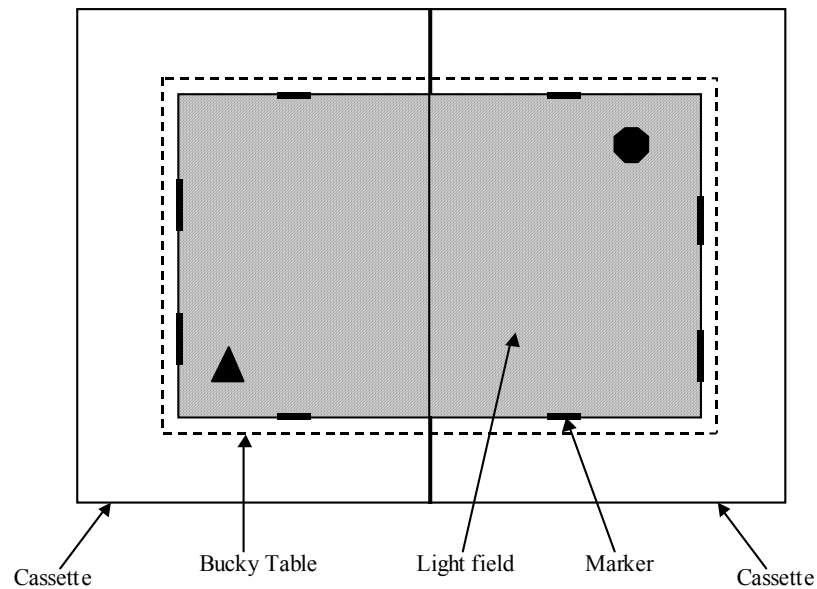



Compression Force

- Maximum force $>150\text{N}$ and $<200\text{N}$
- Thickness indicator accurate to 5mm

Focal Spot Geometry

$$l_{\omega} = l[\tan \phi - \tan \omega] / [\tan \phi - \tan \theta]$$

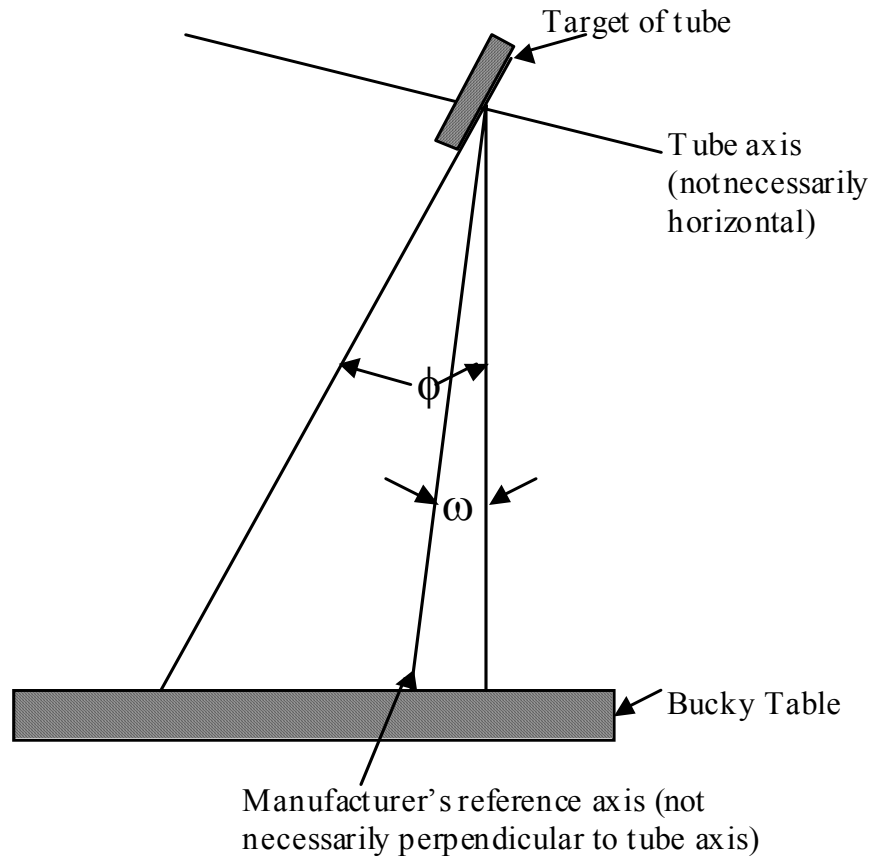



Measurement Methods

- Slit camera $f=d/(M-1)$
- Pin hole
- Star pattern $f = \pi\theta \times D/180(M-1)$



Tube Voltage Measurement

- Accurate to 1 kV
- Remedial level 2 kV
- Digital kV meter

HVL Measurement

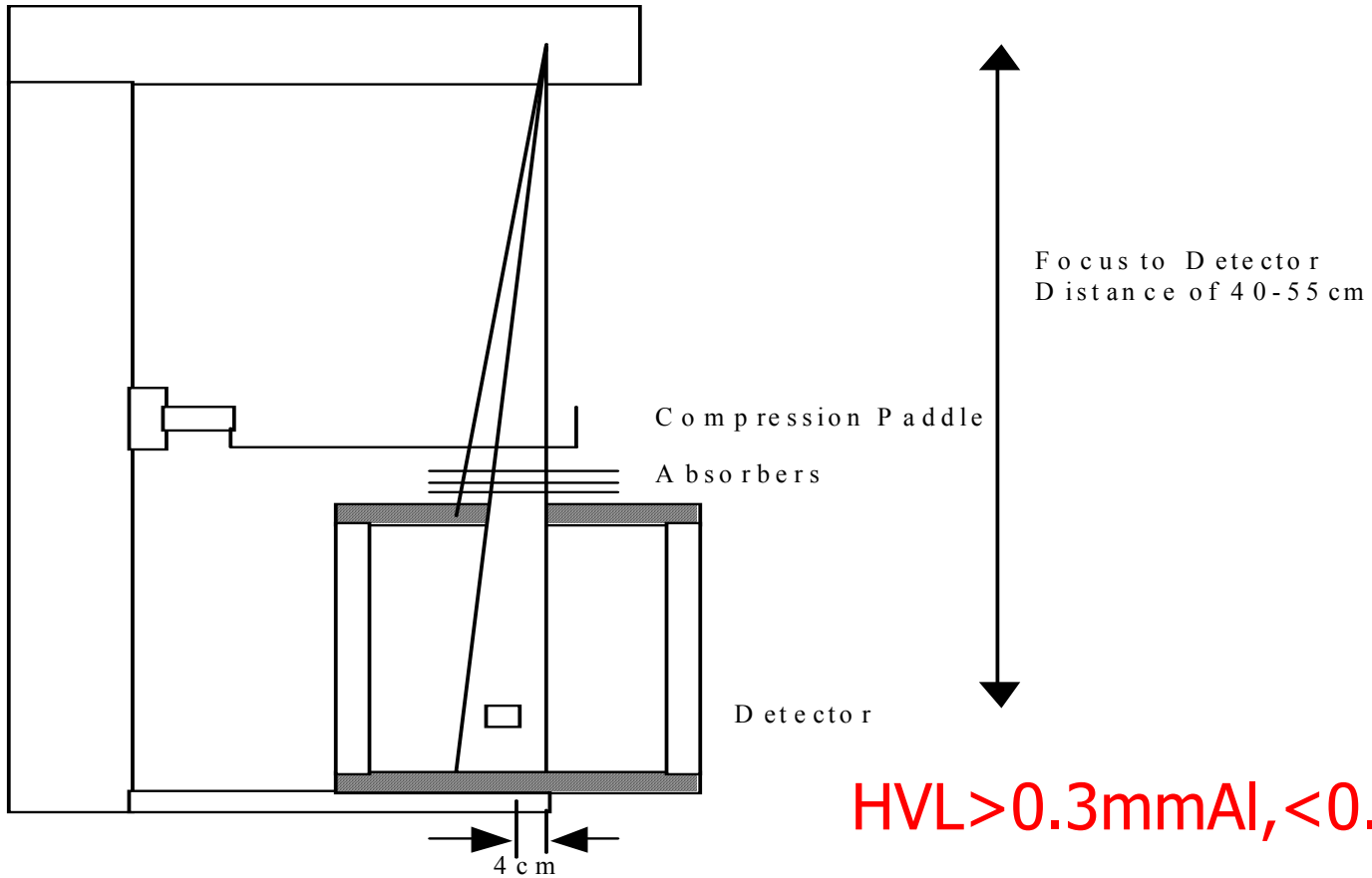

HVL > 0.3mmAl, < 0.4mmAl

Estimated Tube Filtration

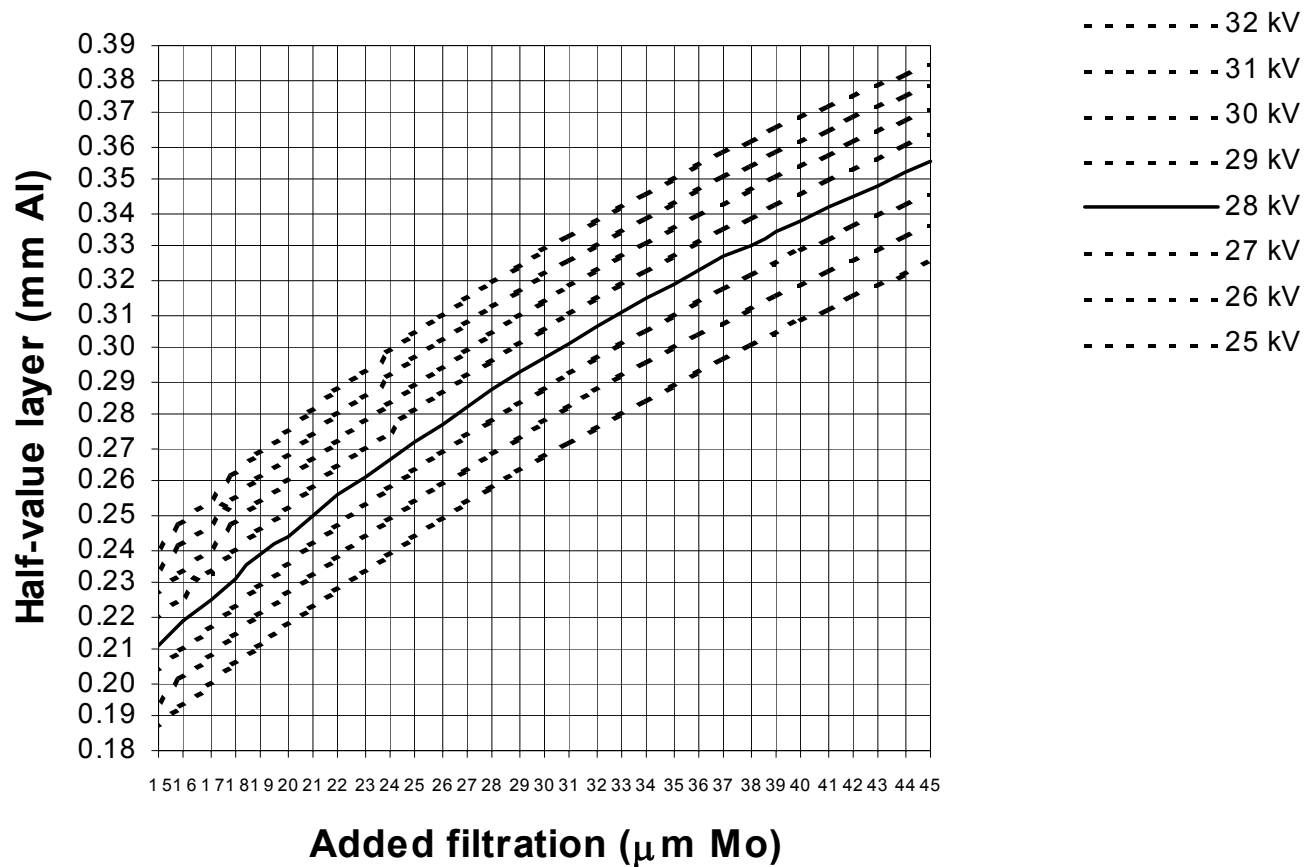



Tube Output

- Repeatability
- Specific output
- Specific output rate
- Variation of output with kV
- Variation of output with mAs

X-ray Uniformity

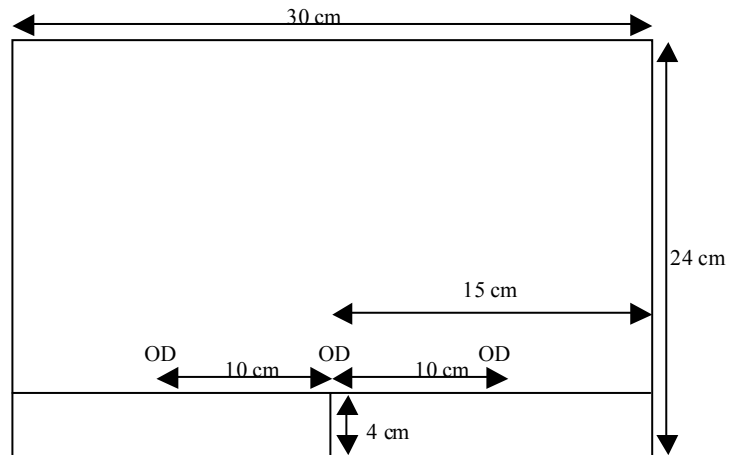
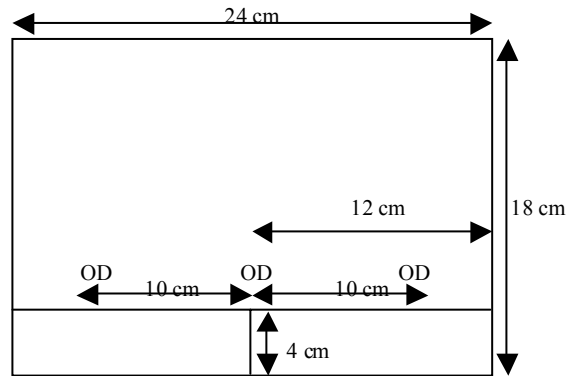



AEC System

- Target density (1.5-1.9)
- Repeatability (5%)
- Constancy with change in thickness (>0.2 , range >0.3)
- Constancy with change in kV (>0.2 , range >0.3)
- Density control
- Guard timer
- Exposure timer ($>1s$)

Sensitometric Curve

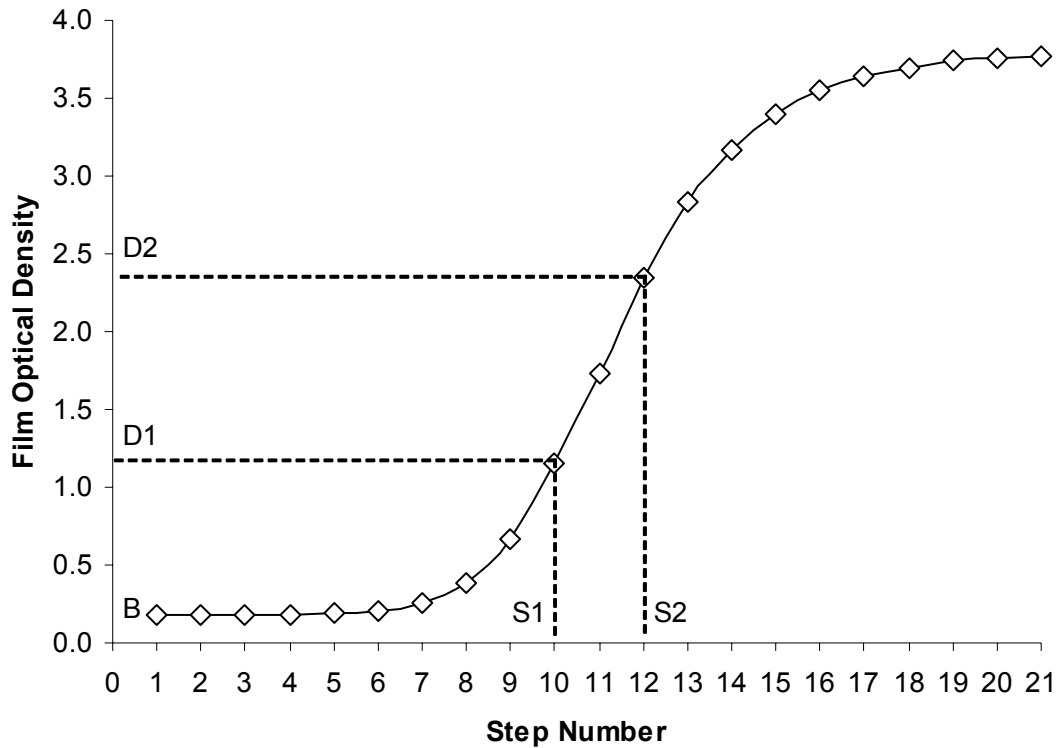

B=base+fog
Speed=D1-B
C=D2-D1



Processing Control Charts

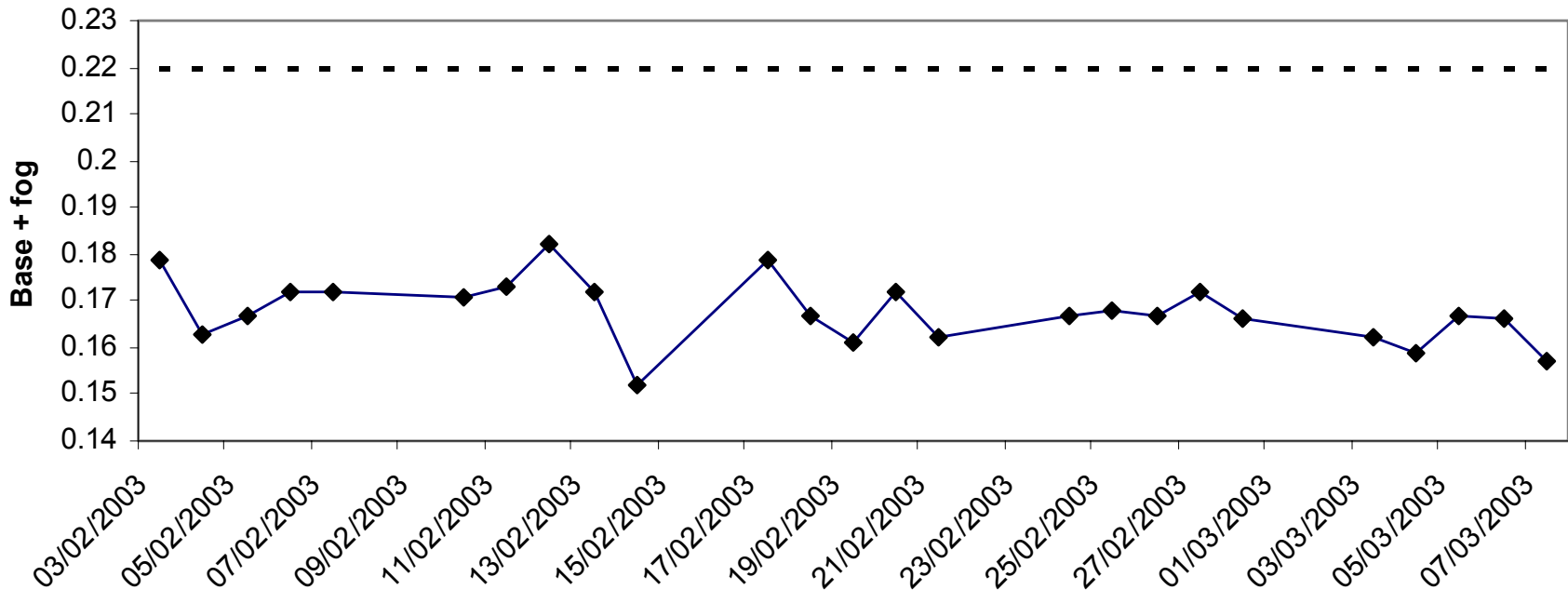

Processing Control Charts

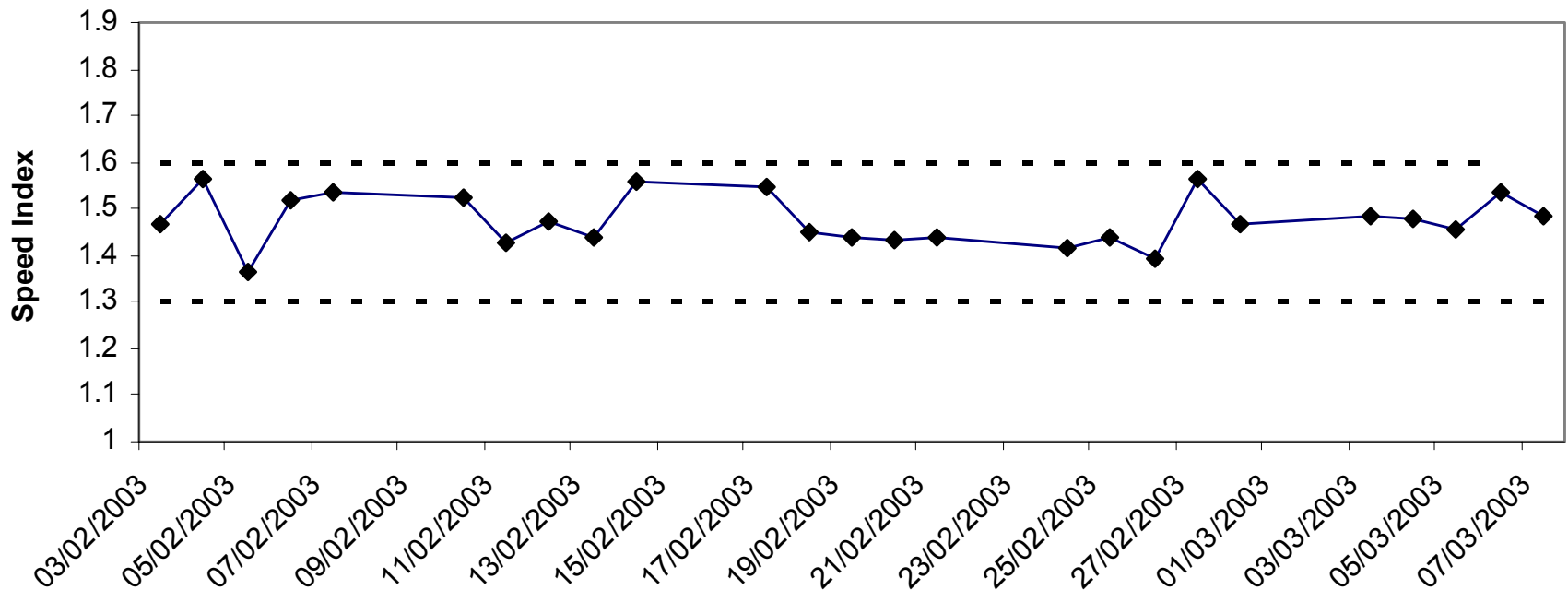

Processing Control Charts

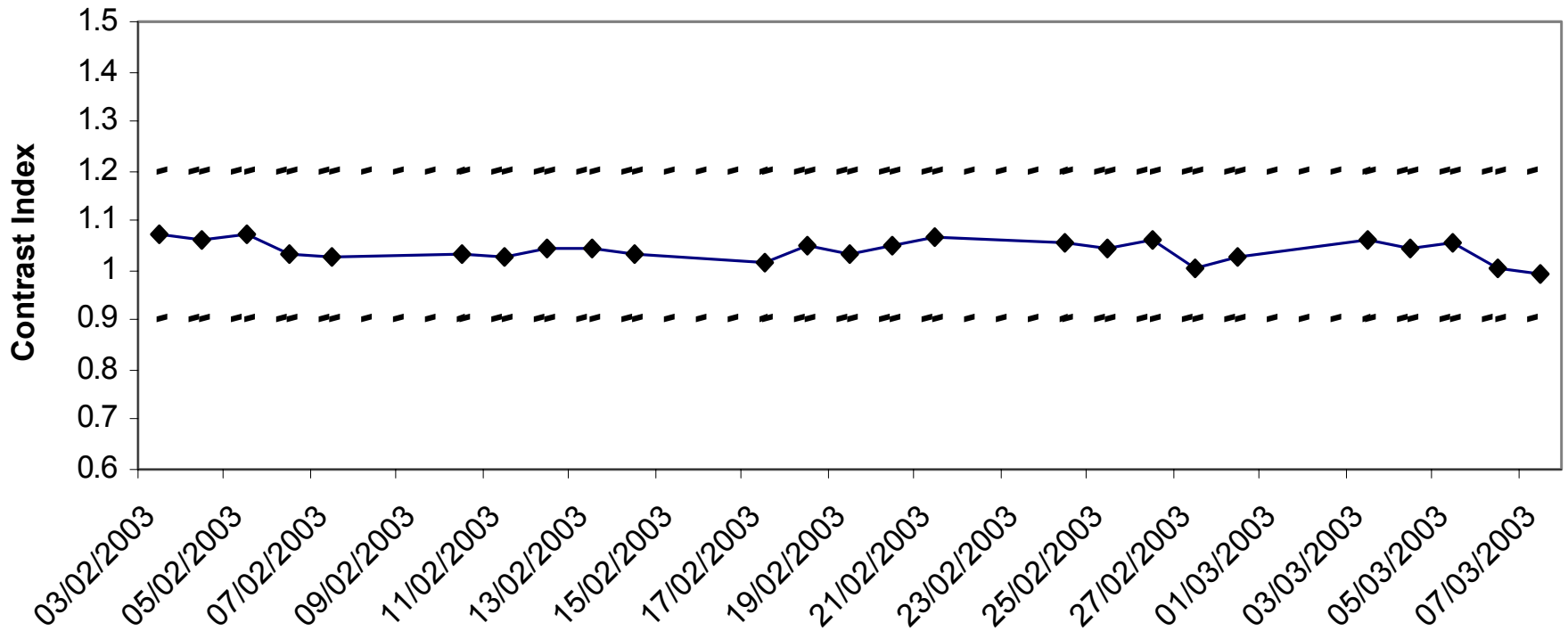

Effect of Delay in Processing

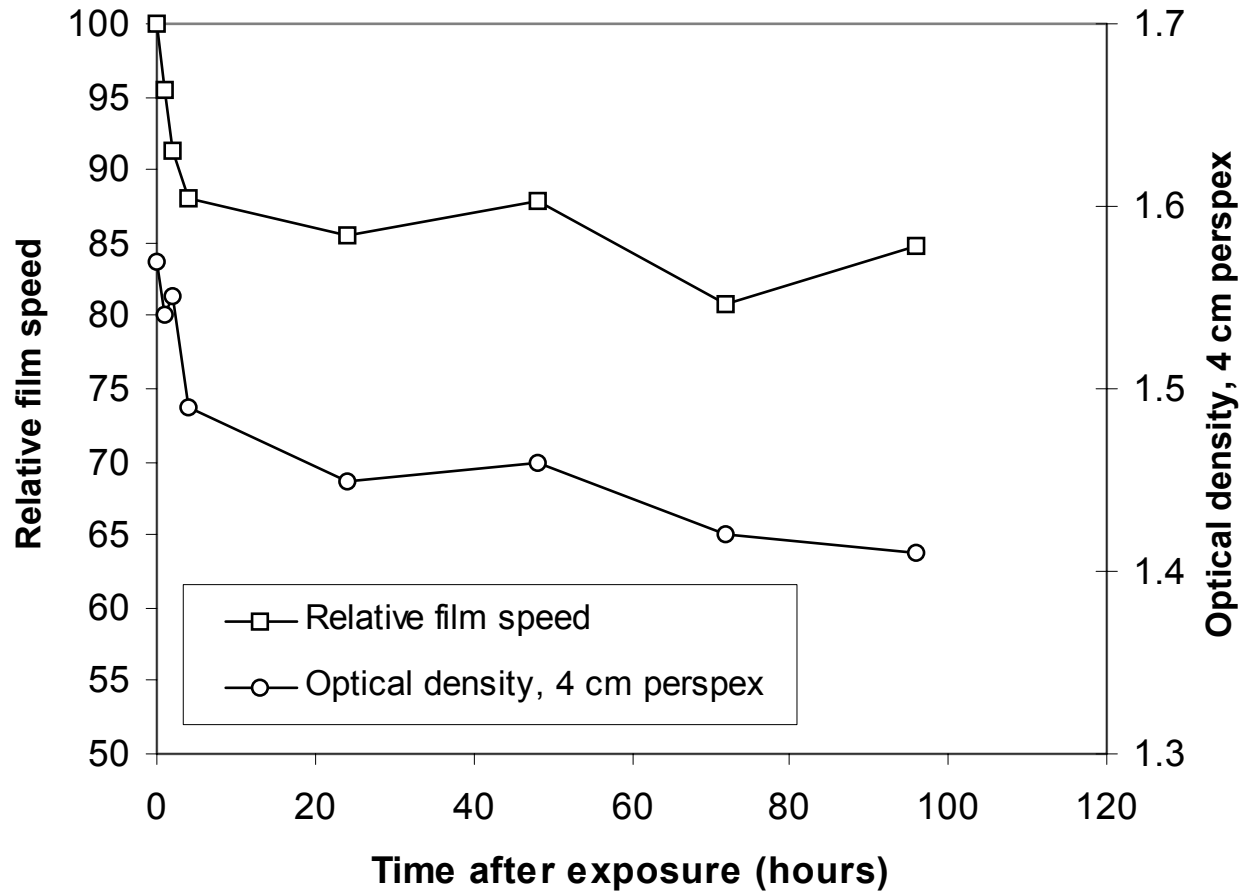



Automatic Film Processor

- Sensitometry
- Temperature (0.5 C)
- Speed (5%)



Film Cassette

- Screen-Film contact
- Sensitivity (0.05)



Illuminators

- Subjective visual check
- Luminance (3000cdm^{-2})
- Luminance (variation $<15\%$ between panels)
- Ambient light (50 lux)



Breast Dose

$$D_{\text{old}} = K p g s$$

p converts incident air Kerma K for perspex phantom
To that of the standard breast

g converts incident air Kerma for standard breast to
mean glandular dose

S is a spectral conversion factor



Breast Dose

$$D_{\text{new}} = K_{4.5} \cdot g_{5.3} \cdot C_{5.3} \cdot S$$

$K_{4.5}$ is the entrance air Kerma for 4.5cm perspex

$G_{5.3}$ is the g factor for 5.3cm standard breast

$C_{5.3}$ is the glandularity factor for 5.3cm

S is a spectral conversion factor



Conversion Factors

| HVL (mm Al) | g (mGy/mGy) | c | product of g and c |
|----------------|------------------|-------|------------------------|
| 0.30 | 0.155 | 1.109 | 0.172 |
| 0.35 | 0.177 | 1.105 | 0.196 |
| 0.40 | 0.198 | 1.102 | 0.218 |
| 0.45 | 0.220 | 1.099 | 0.242 |
| 0.50 | 0.245 | 1.096 | 0.269 |
| 0.55 | 0.272 | 1.091 | 0.297 |
| 0.60 | 0.295 | 1.088 | 0.321 |



Mean Glandular Dose Standard Breast

$$\text{Air Kerma (K)} = T \cdot \text{mAs}_{\text{exp}} \cdot (50/d)^2$$

The mAs/exposure is determined using the perspex phantom

T is the tube output at 50cm

D is the focus phantom distance



Mean Glandular Dose Real Breasts

$$D = Kgcs$$

K is the incident air Kerma at the upper surface of the breast

g is the glandularity conversion factor

c converts from 50% glandularity

s is the spectral conversion factor



Conversion Factors g

| Breast Thickness cm | HVL mm Al | | | | | | |
|------------------------|-----------|--------|--------|--------|--------|--------|--------|
| | 0.30 | 0.35 | 0.40 | 0.45 | 0.50 | 0.55 | 0.60 |
| 2 | 0.390 | 0.433 | 0.473 | 0.509 | 0.543 | 0.573 | 0.587 |
| 3 | 0.274 | 0.309 | 0.342 | 0.374 | 0.406 | 0.437 | 0.466 |
| 4 | 0.207 | 0.235 | 0.261 | 0.289 | 0.318 | 0.346 | 0.374 |
| 4.5 | 0.183 | 0.208 | 0.232 | 0.258 | 0.285 | 0.311 | 0.339 |
| 5 | 0.164 | 0.187 | 0.209 | 0.232 | 0.258 | 0.287 | 0.310 |
| 6 | 0.135 | 0.154 | 0.172 | 0.192 | 0.214 | 0.236 | 0.261 |
| 7 | 0.114 | 0.130 | 0.145 | 0.163 | 0.177 | 0.202 | 0.224 |
| 8 | 0.098 | 0.112 | 0.126 | 0.140 | 0.154 | 0.175 | 0.195 |
| 9 | 0.0859 | 0.0981 | 0.1106 | 0.1233 | 0.1357 | 0.1543 | 0.1723 |
| 10 | 0.0763 | 0.0873 | 0.0986 | 0.1096 | 0.1207 | 0.1375 | 0.1540 |
| 11 | 0.0687 | 0.0786 | 0.0887 | 0.0988 | 0.1088 | 0.1240 | 0.1385 |



Conversion Factors g

| Breast Thickness cm | HVL mm Al | | | | | | |
|------------------------|-----------|--------|--------|--------|--------|--------|--------|
| | 0.30 | 0.35 | 0.40 | 0.45 | 0.50 | 0.55 | 0.60 |
| 2 | 0.390 | 0.433 | 0.473 | 0.509 | 0.543 | 0.573 | 0.587 |
| 3 | 0.274 | 0.309 | 0.342 | 0.374 | 0.406 | 0.437 | 0.466 |
| 4 | 0.207 | 0.235 | 0.261 | 0.289 | 0.318 | 0.346 | 0.374 |
| 4.5 | 0.183 | 0.208 | 0.232 | 0.258 | 0.285 | 0.311 | 0.339 |
| 5 | 0.164 | 0.187 | 0.209 | 0.232 | 0.258 | 0.287 | 0.310 |
| 6 | 0.135 | 0.154 | 0.172 | 0.192 | 0.214 | 0.236 | 0.261 |
| 7 | 0.114 | 0.130 | 0.145 | 0.163 | 0.177 | 0.202 | 0.224 |
| 8 | 0.098 | 0.112 | 0.126 | 0.140 | 0.154 | 0.175 | 0.195 |
| 9 | 0.0859 | 0.0981 | 0.1106 | 0.1233 | 0.1357 | 0.1543 | 0.1723 |
| 10 | 0.0763 | 0.0873 | 0.0986 | 0.1096 | 0.1207 | 0.1375 | 0.1540 |
| 11 | 0.0687 | 0.0786 | 0.0887 | 0.0988 | 0.1088 | 0.1240 | 0.1385 |



Conversion Factor c

50-64 years

| Breast thickness (cm) | HVL (mm Al) | | | | | | |
|-----------------------------|-------------|-------|-------|-------|-------|-------|-------|
| | 0.30 | 0.35 | 0.40 | 0.45 | 0.50 | 0.55 | 0.60 |
| 2 | 0.885 | 0.891 | 0.900 | 0.905 | 0.910 | 0.914 | 0.919 |
| 3 | 0.925 | 0.929 | 0.931 | 0.933 | 0.937 | 0.940 | 0.941 |
| 4 | 1.000 | 1.000 | 1.000 | 1.000 | 1.000 | 1.000 | 1.000 |
| 5 | 1.086 | 1.082 | 1.081 | 1.078 | 1.075 | 1.071 | 1.069 |
| 6 | 1.164 | 1.160 | 1.151 | 1.150 | 1.144 | 1.139 | 1.134 |
| 7 | 1.232 | 1.225 | 1.214 | 1.208 | 1.204 | 1.196 | 1.188 |
| 8 | 1.275 | 1.265 | 1.257 | 1.254 | 1.247 | 1.237 | 1.227 |
| 9 | 1.299 | 1.292 | 1.282 | 1.275 | 1.270 | 1.260 | 1.249 |
| 10 | 1.307 | 1.298 | 1.290 | 1.286 | 1.283 | 1.272 | 1.261 |
| 11 | 1.306 | 1.301 | 1.294 | 1.291 | 1.283 | 1.274 | 1.266 |



Standard Breast

- 50:50 adipose/glandular tissue, superficial region of 0.5cm adipose tissue
- 4.5 cm compressed thickness
- Area 100cm²



Conversion Factors

HVL
(mm Al)

p

g
(mGy/mGy)

0.25

1.12

0.155

0.30

1.10

0.183

0.35

1.10

0.208

0.40

1.09

0.232

0.45

1.09

0.258

0.50

1.09

0.285

0.55

1.07

0.311

0.60

1.06

0.339



Conversion Factors

Spectrum

s-factor

Mo/Mo

1.000

Mo/Rh

1.017

Rh/Rh

1.061

Rh/Al

1.044

W/Rh

1.042

TOR (MAM)

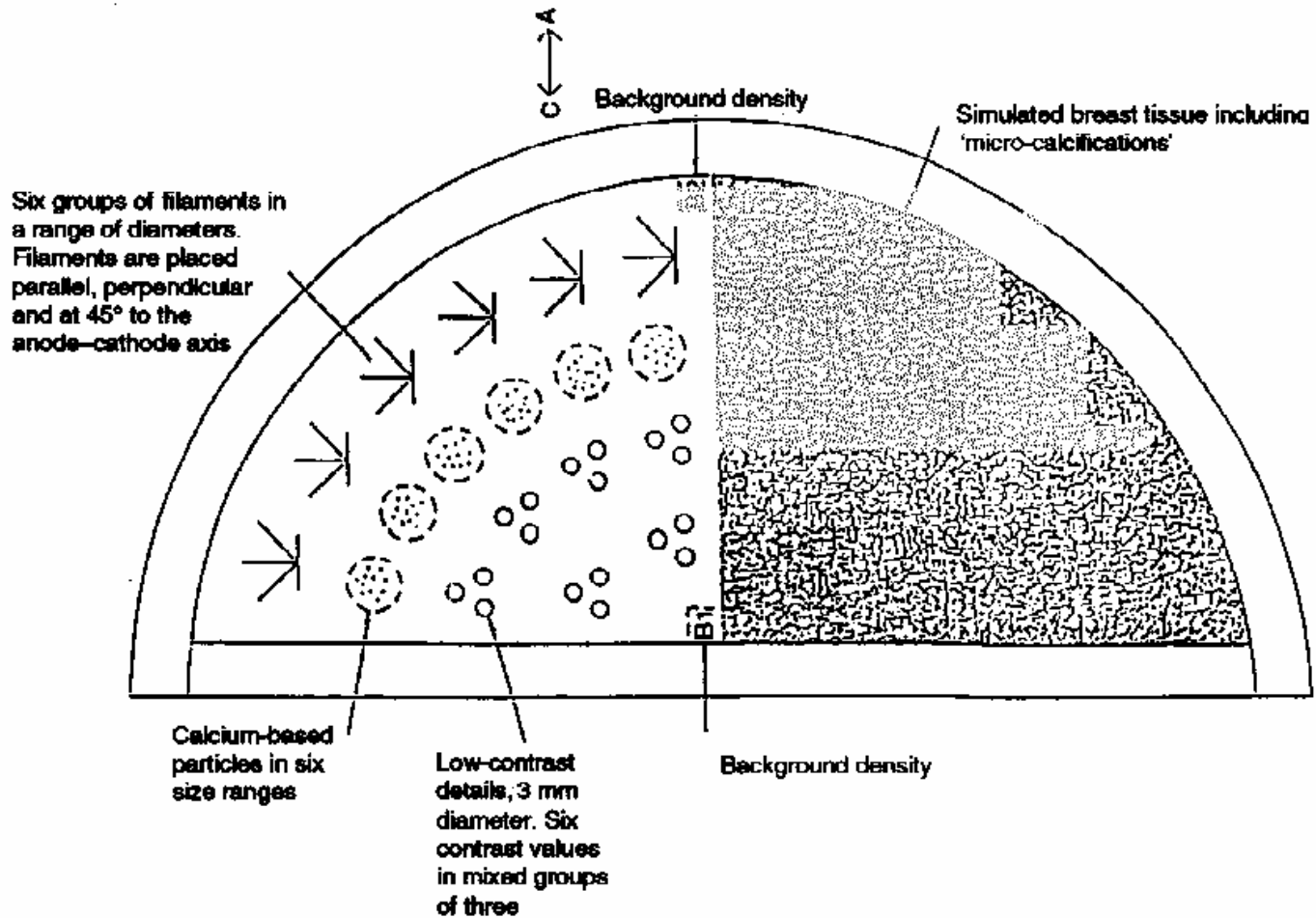

Contrast Detail Diagram

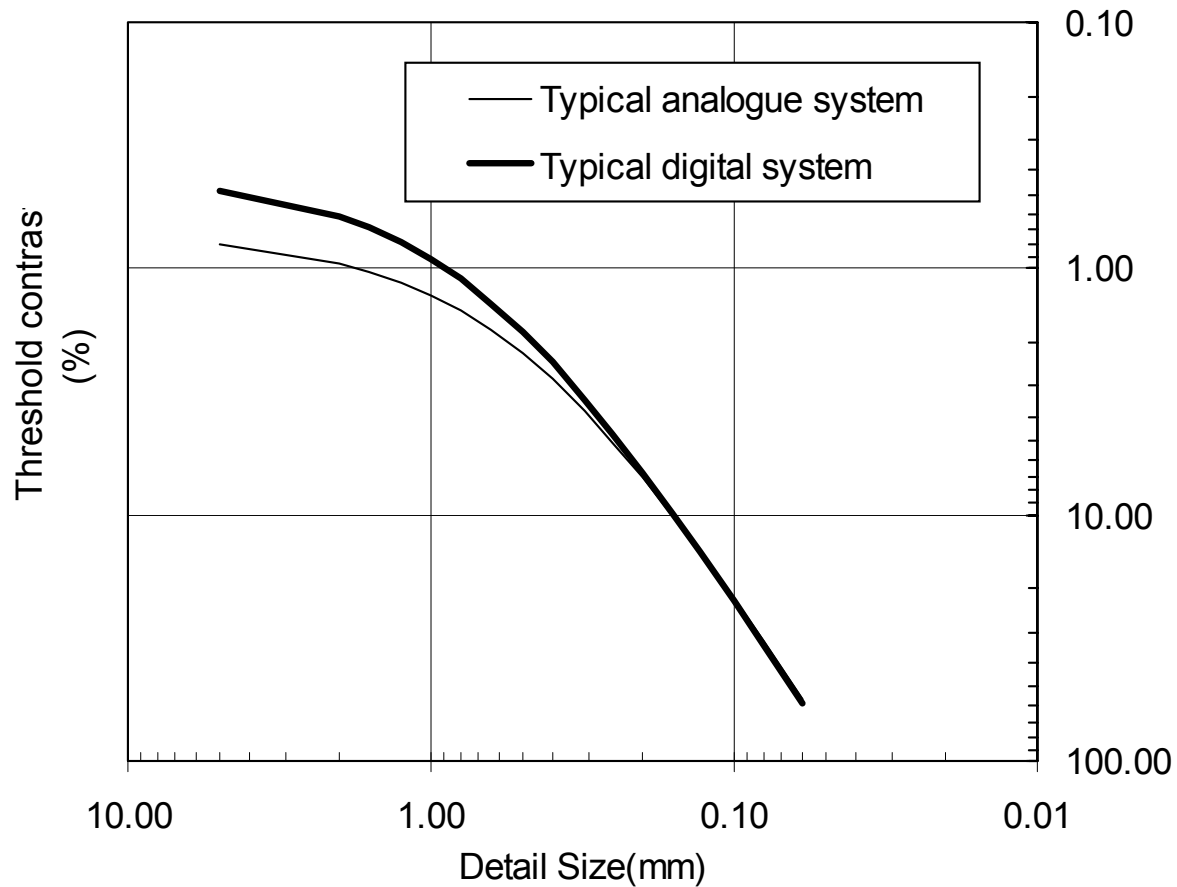
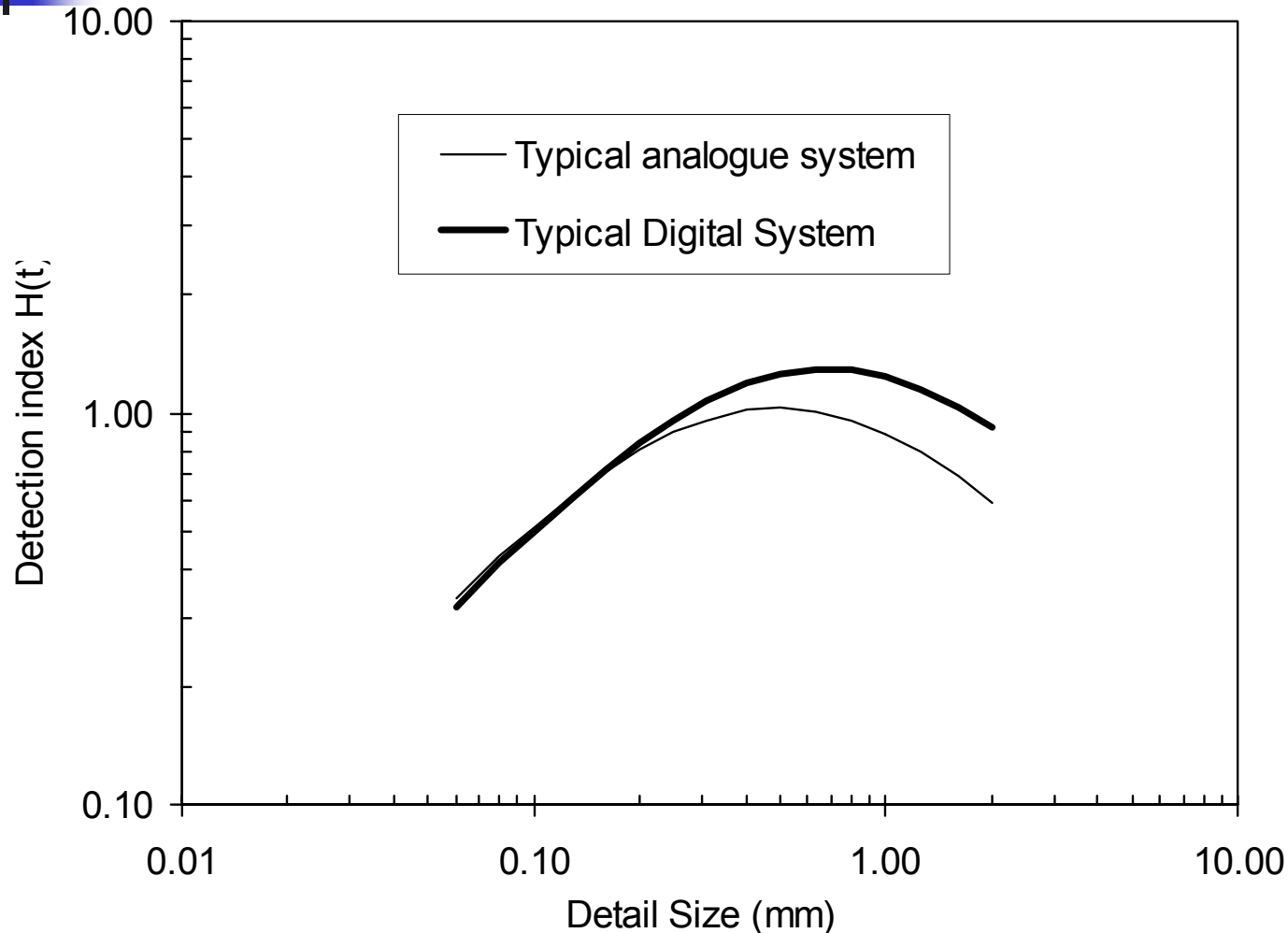
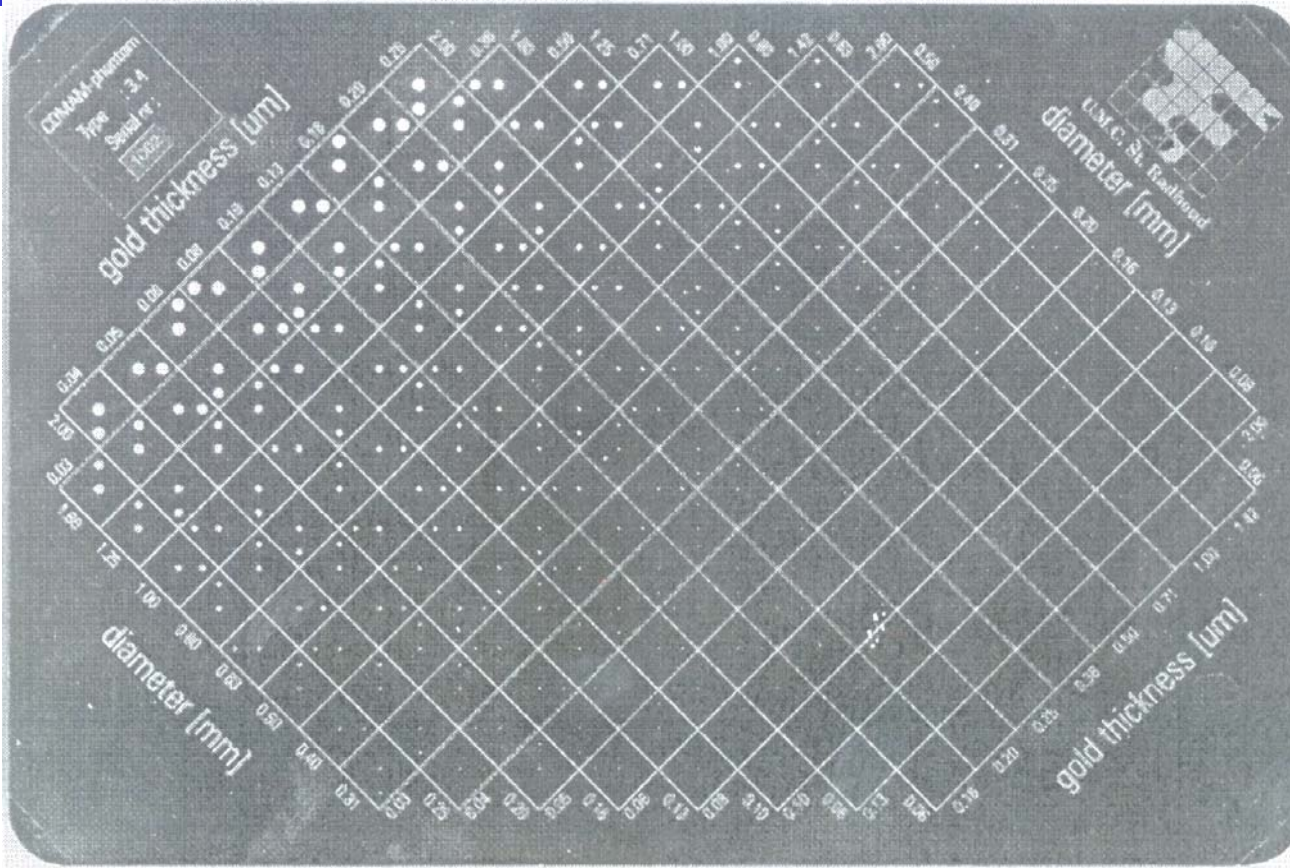

Image Quality CDMAM Phantom Detection Index



CDMAM Test Object



TOR(MAX)

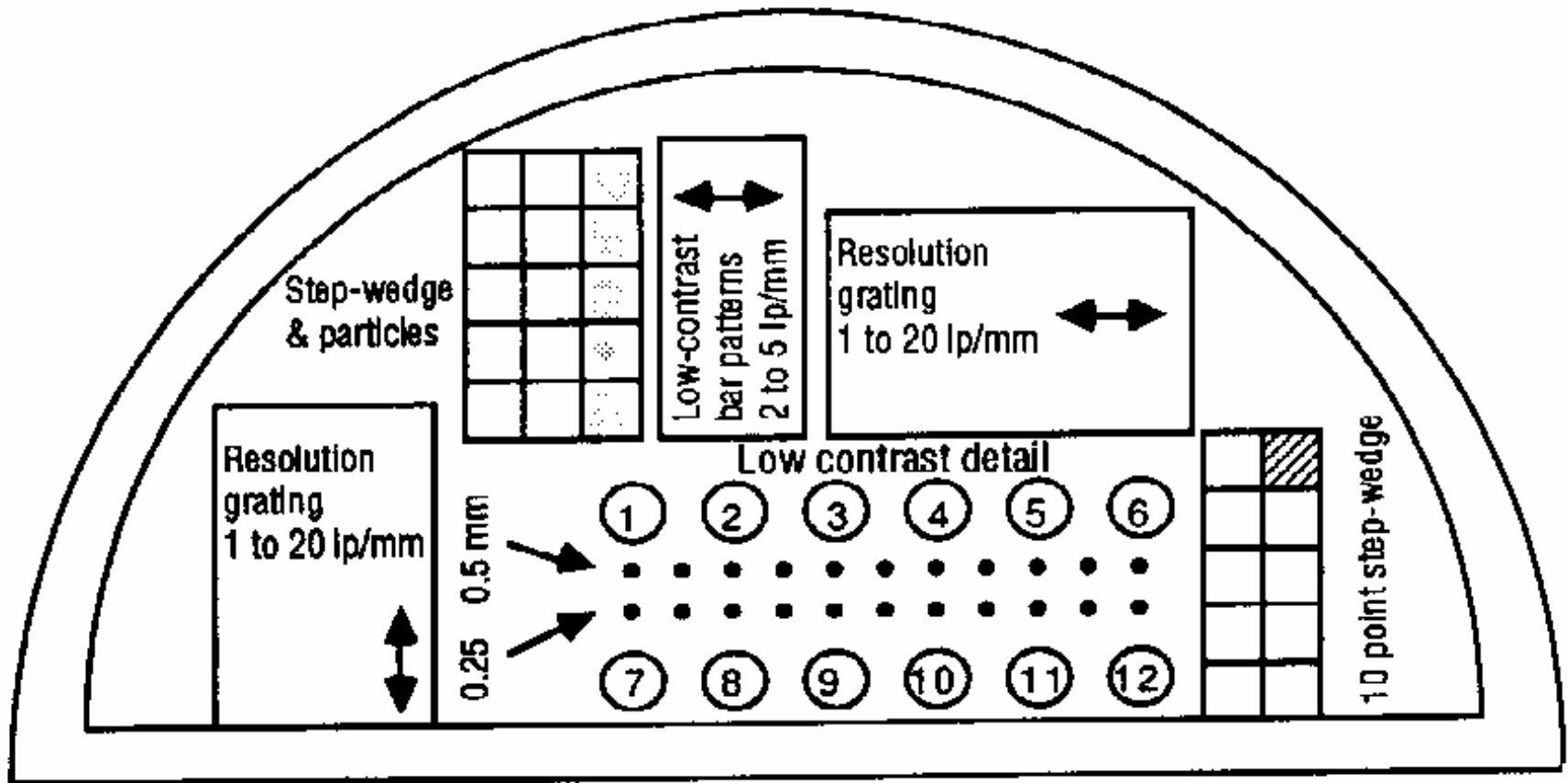

High Contrast Resolution

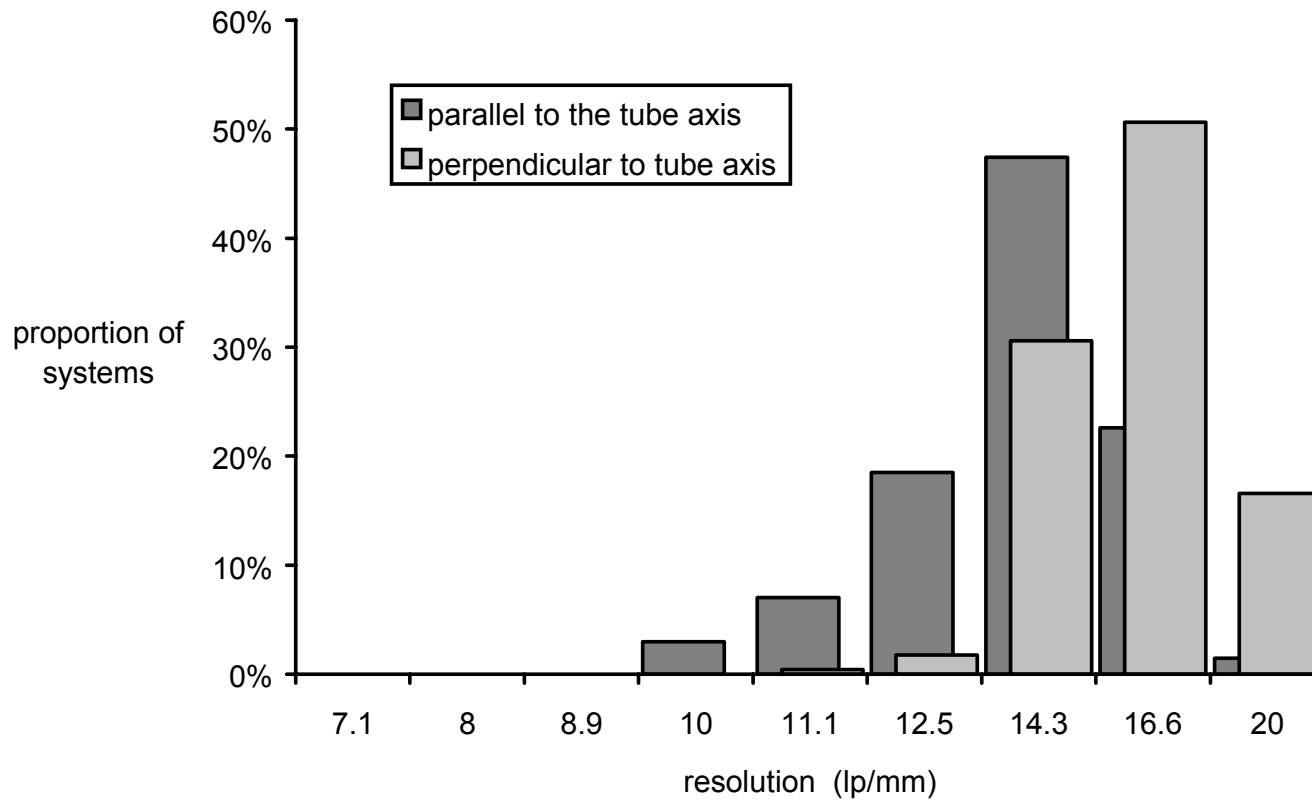

Threshold Contrast Measurements (0.25mm)

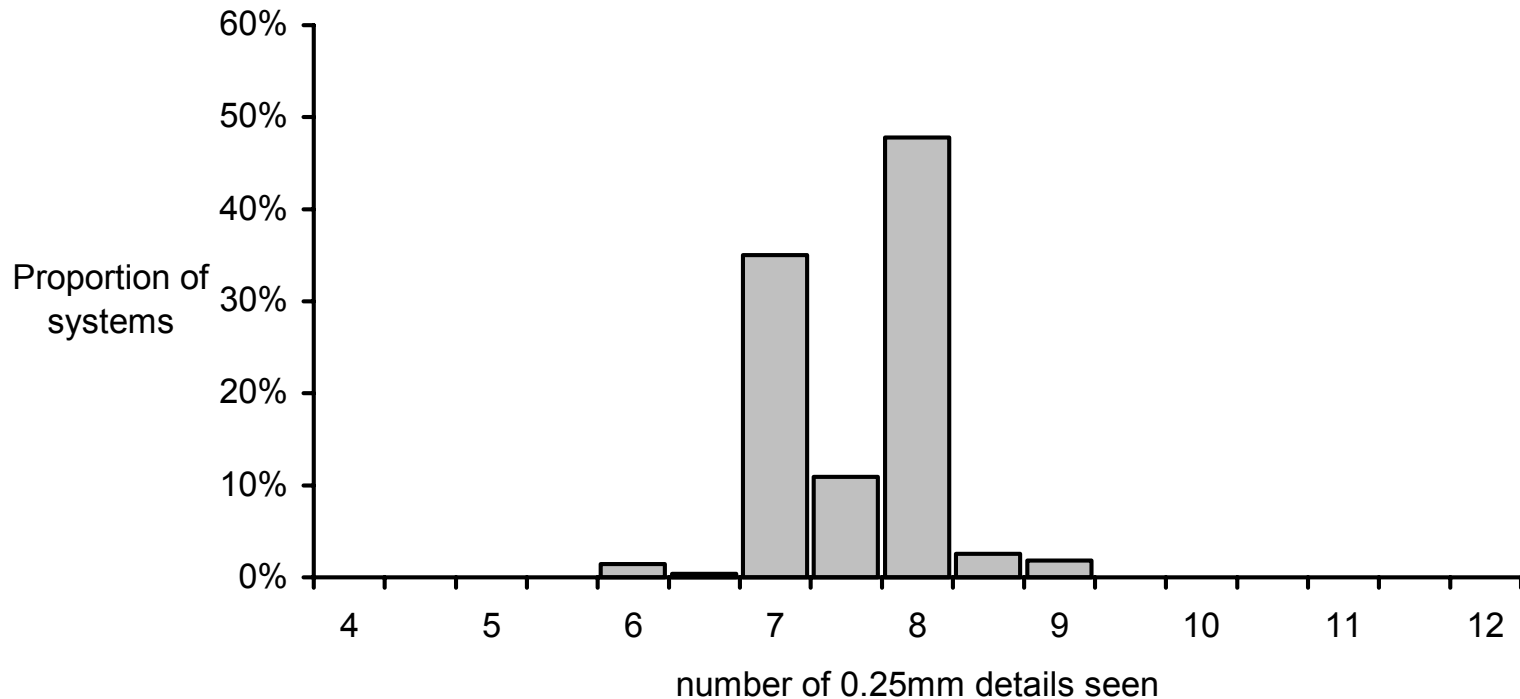

Threshold Contrast (0.5mm)

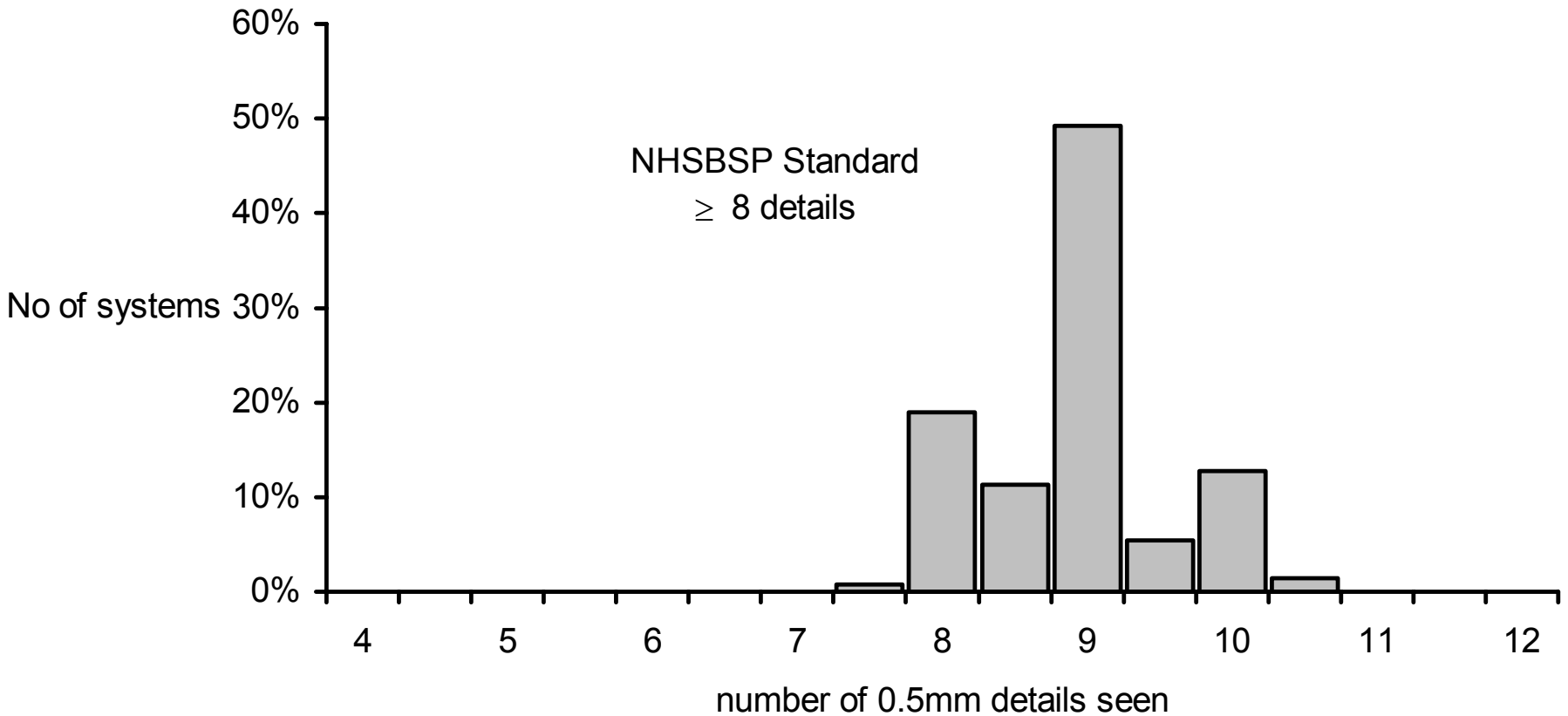

Stereotactic Assessment

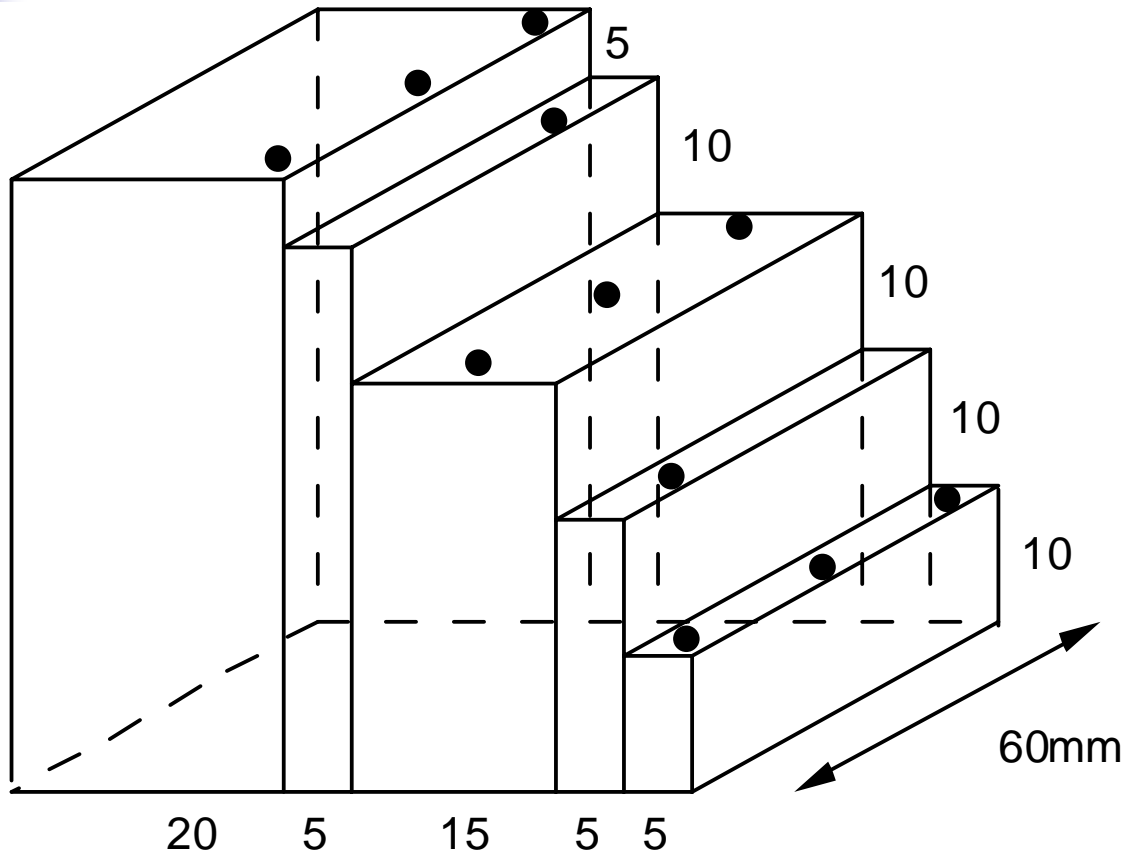



Performance Measurements

| Parameter | minimum | 25th percentile | mean | 75th percentile | maximum | unit |
|---|---------|-----------------|------|-----------------|---------|--------|
| measured kV at 28 kV set | 26.9 | 27.7 | 27.9 | 28.2 | 29.5 | kVp |
| output at broad focus at 28 kV Mo/Mo (at 50 cm) | 136 | 182 | 201 | 220 | 282 | Gy/mAs |
| output per second at FFD at 28 kV Mo/Mo | 7.81 | 11.5 | 15.5 | 19.2 | 29.2 | mGy/s |
| HVL at 28kV with compression paddle | .30 | .34 | .35 | .365 | .41 | mm Al |
| broad focus width | .11 | .30 | .35 | .39 | .63 | mm |
| broad focus length | .19 | .42 | .53 | .62 | 1.09 | mm |
| fine focus width | .05 | .10 | .13 | .16 | .45 | mm |
| fine focus length | .05 | .12 | .16 | .19 | .37 | mm |
| Separation between film edge and table edge | 1 | 3 | 3.2 | 4 | 6 | mm |
| Overlap of X-ray field at chest wall edge | -2 | 1 | 2.0 | 3 | 11.2 | mm |
| Maximum compression force (automatically applied) | 90 | 150 | 170 | 190 | 255 | N |
| AEC consistency (a) | .00% | .01% | .75% | 1.01% | 7.7% | % |
| AEC error with 2 cm Perspex (b) | -.35 | -.09 | -.03 | .02 | 0.22 | OD |
| AEC error with 6 cm Perspex (b) | -.70 | -.08 | -.02 | .05 | 0.35 | OD |
| film density for 4cm Perspex using AEC at clinical settings | 1.31 | 1.58 | 1.66 | 1.74 | 2.23 | OD |
| Exposure times for 4cm Perspex | .16 | .32 | .53 | .64 | 1.74 | s |
| Exposure times for 6cm Perspex | .58 | 1.21 | 1.78 | 2.22 | 4.12 | s |
| mean glandular dose to old standard breast (at 28 kV Mo/Mo) | .65 | 1.13 | 1.36 | 1.61 | 2.60 | mGy |
| mean glandular dose to old standard breast (at clinical settings) | .69 | 1.20 | 1.40 | 1.56 | 2.60 | mGy |
| high contrast resolution parallel to tube axis (c) | 10.0 | 13.0 | 14.0 | 14.5 | 20.0 | lp/mm |
| high contrast resolution perpendicular to tube axis (c) | 11.0 | 15.0 | 16.1 | 17.0 | 20.0 | lp/mm |